

CLAMP TITE™

INSTRUCTIONS FOR USE

To Make a Hose Clamp

1. Measure the diameter where the clamp will be applied. Cut wire to length (15 times the diameter plus 12 inches.) Fold the wire in the middle to make a loop.
2. Wrap the free ends of the wire around the assembled hose and fitting, and pass both free ends through the loop together. Go around once, twice, or more for a stronger clamp. **(Figure 1)**
3. Push the notch in the nose of the tool against the loop. Pull the free wires over the short pin, and wrap around the long hollow pin on each side of the Clamptite™. Then twist the free ends together. **(Figure 2)**
4. Turn the wing nut to draw the threaded rod out of the cylinder. This pulls the wire tight around the hose and forms the clamp. **(Figure 3)**
5. When the wire is tight enough, rotate the tool over the loop. This clinches the wire clamp. **(Figure 4)**
6. Clip the wire with diagonal cutters near the nose of the tool, leaving about ¼ inch tails. Snug the tails down, and the clamp is done.

Most users learn to complete these steps in under 1 minute without hurrying.

For additional tools and wire:

Joseph Riden
J. Albert Netsales
412 Olive Avenue #246
Huntington Beach, CA 92648-5412

714-402-3217

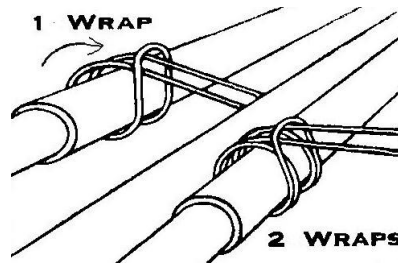

FIGURE 1

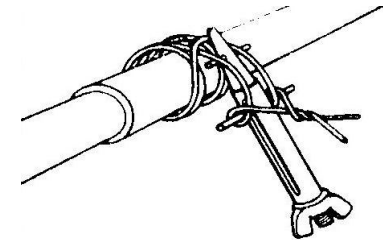

FIGURE 2

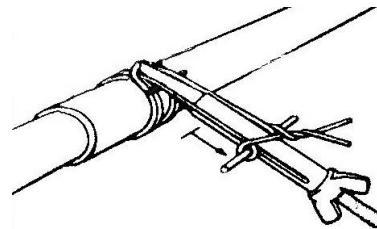

FIGURE 3

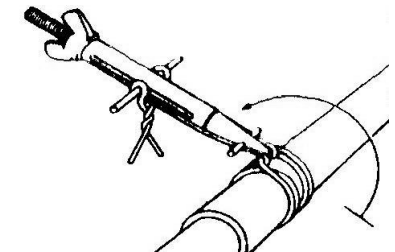
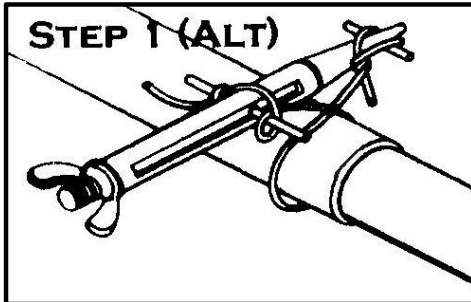
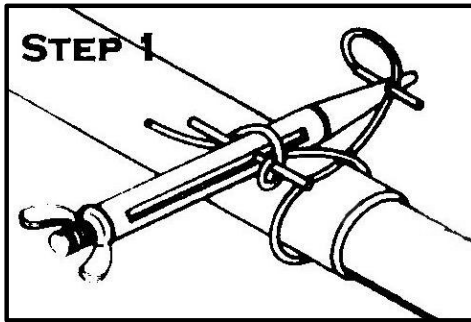

FIGURE 4



Quick and easy alternative style wrap. (Not for hose clamps.)

Rig and wrap the wire one or more turns.

Turn the nut or knob to tighten.

Rotate the tool 360 degrees as shown in STEP 2 below to lock the wrap. Then clip the wire ends leaving about 1/4 inch tail.

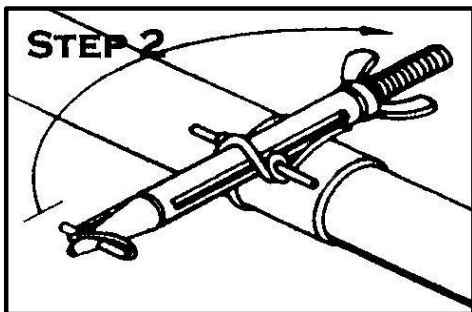

Joseph Riden
 J. Albert Netsales
 412 Olive Avenue #246
 Huntington Beach, CA 92648-5412

714-402-3217



INSTRUCTIONS AND PRICE LIST

We appreciate your business.

Expect many years of good service from your new Clamptite tool.

If you bought from us on Ebay or in our Internet Store, please leave us some good feedback.

Your comments and suggestions are always welcome.

QTY	DESCRIPTION	PRICE EACH	TOTAL ACROSS
	MARINE GRADE TOOL ALL STAINLESS BRONZE KNOB	\$69.95	
	PROFESSIONAL TOOL STAINLESS/ALUMINUM WING NUT	\$39.95	
	STANDARD TOOL PLATED STEEL/ALUMINUM WING NUT	\$29.95	
	INDUSTRIAL TOOL LARGE STAINLESS/ALUMINUM HEX NUT	\$89.95	
	BRONZE KNOB	\$9.95	
	WIRE .041 APPROX 50 FT. STAINLESS	\$11.95	
	WIRE .041 APPROX 25 FT. MONEL	\$11.95	
	WIRE .041 APPROX 165 FT. STAINLESS	\$21.95	
	SHIPPING (ONE SMALL TOOL & 2 SMALL WIRE)	\$6.95	
		TOTAL	

LIFETIME WARRANTY: Clamptite will replace this product at no charge if found defective, and returned at buyer's expense. Replacement is buyer's sole remedy. There are no other expressed or implied warranties. Clamptite can not guarantee specific results because it does not control the application of the tool.